

Metal fitting for fixing the electric wire for surface mounting

HO series

- This metal fitting can fix the electric wire on a surface mounting board.
- After the reflow, please insert the electric wire and press it from above to fix.
- Material: Brass
- Finish: Tin plating over nickel base
- Recommended land information

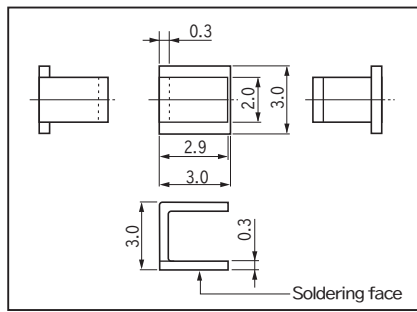
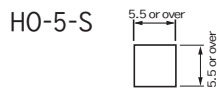
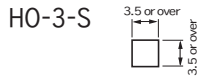

HO-3-S

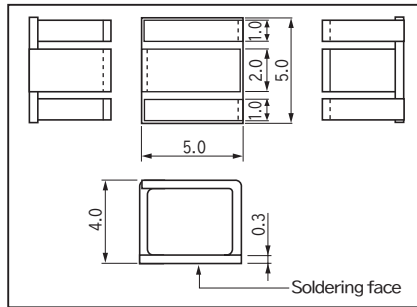

HO-5-S

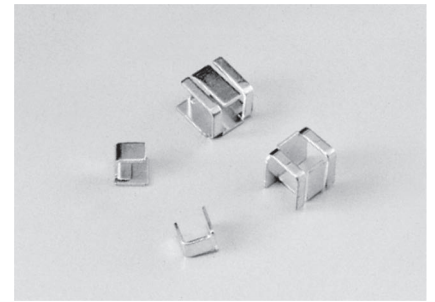

■ Example of usage

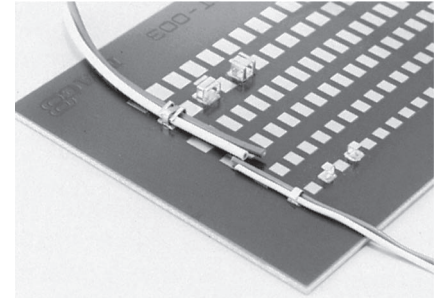

■ Part No.

Part No.	Package	Tape width
HO-3-S	Bulk (1000pcs/pack)	—
HO-3-S-T	Reel (700pcs/reel)	8
HO-5-S	Bulk (1000pcs/pack)	—
HO-5-S-T	Reel (500pcs/reel)	12

■ HO-3-S-T

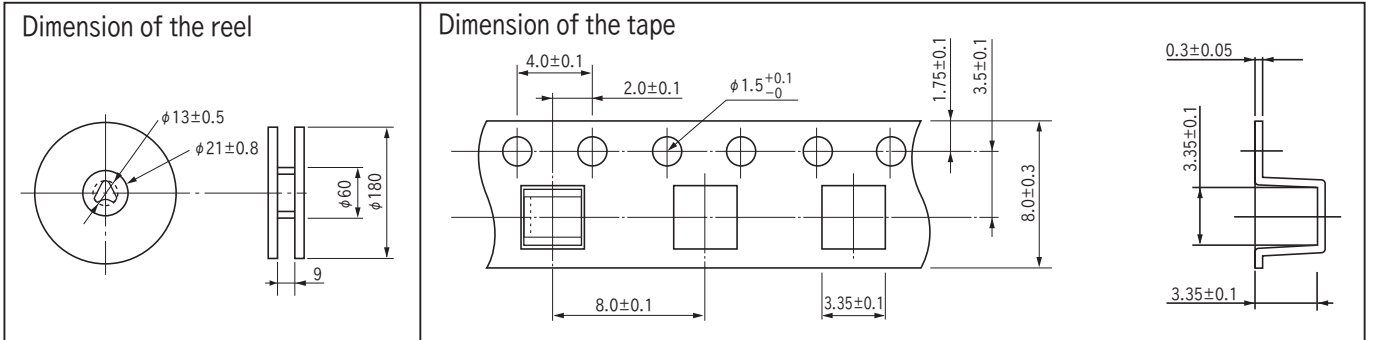

■ HO-5-S-T

