

## Metal fitting for fixing the electric wire for surface mounting [HO series]

- This metal fitting can fix the electric wire on a surface mounting board.
- After the reflow, please insert the electric wire and press it from above to fix.
- Material: Brass
- Finish: Tin plating over nickel base
- Recommended land diameter

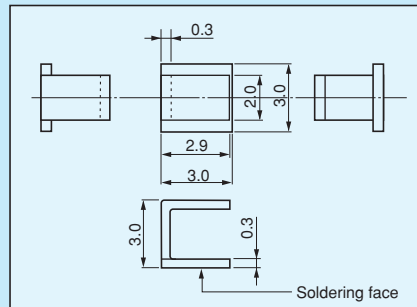

HO-3-S

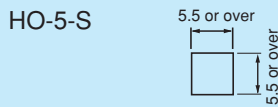
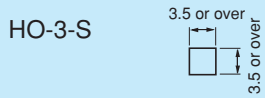
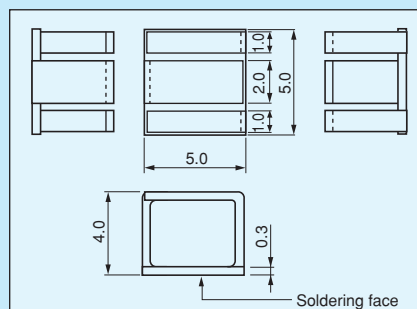
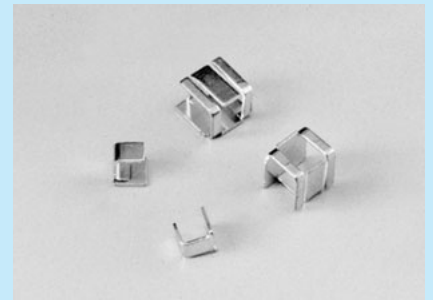

HO-5-S

### Example of usage

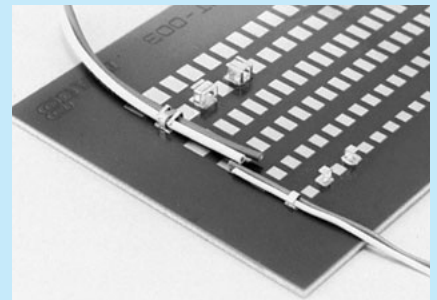

### Part number

Part number	Package	Tape width
HO-3-S	Bulk (1000pcs/pack)	
HO-3-S-T	Reel (700pcs/reel)	8
HO-5-S	Bulk (1000pcs/pack)	
HO-5-S-T	Reel (500pcs/reel)	12

### HO-3-S-T

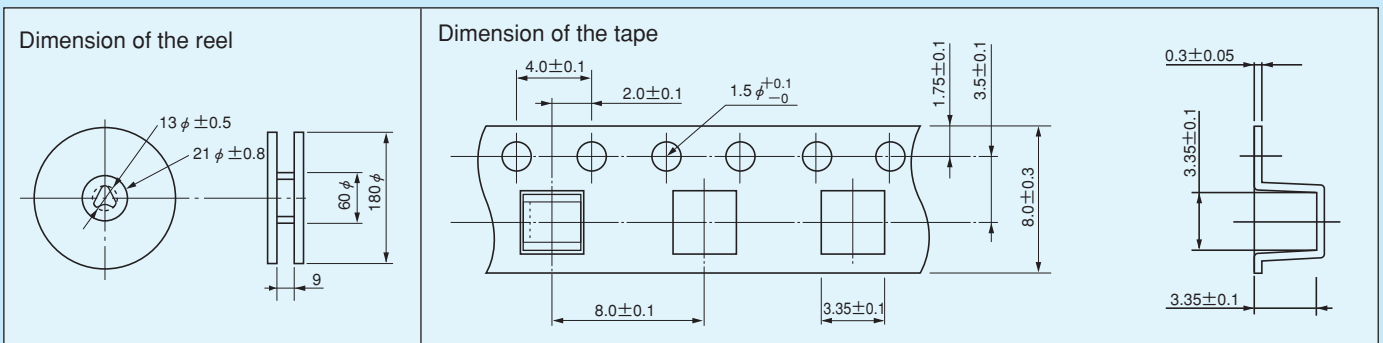

### HO-5-S-T

