

## Through hole tap [THC-0.8 series]

- A chip mounter can be used for this spacer.
- A spacer can be fit on a PC board just by automatically loading it on the PC board and carrying out reflow.
- Spacer with an unloaded hole can be fit on a PC board.
- Tape-and-reel has an adsorption film. Please remove by pushing it from the opposite side after reflow.
- The jig for removing adsorption films (Part number: TH-JIG) is available.
- Material: Brass
- Finish: Tin plating over nickel base
- Adaptive printed board thickness: 0.8t or over (There is no problem if it is used for other board thickness.)
- Please use the automatic mounter of automatic recognition type.

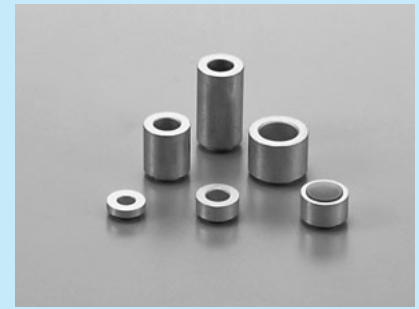

### Part number

Part number	A	B	C	H	Number of taps included in the reel
THC-0.8-0.5-2	4.5	3.0	2.1	0.5	450pcs
THC-0.8-1.0-2	4.5	3.0	2.1	1.0	450pcs
THC-0.8-1.5-2	4.5	3.0	2.1	1.5	300pcs
THC-0.8-2.0-2	4.5	3.0	2.1	2.0	300pcs
THC-0.8-2.5-2	4.5	3.0	2.1	2.5	250pcs
THC-0.8-3.0-2	4.5	3.0	2.1	3.0	250pcs
THC-0.8-3.5-2	4.5	3.0	2.1	3.5	200pcs
THC-0.8-4.0-2	4.5	3.0	2.1	4.0	200pcs
THC-0.8-4.5-2	4.5	3.0	2.1	4.5	400pcs
THC-0.8-5.0-2	4.5	3.0	2.1	5.0	400pcs
THC-0.8-5.5-2	4.5	3.0	2.1	5.5	350pcs
THC-0.8-6.0-2	4.5	3.0	2.1	6.0	350pcs
THC-0.8-6.5-2	4.5	3.0	2.1	6.5	300pcs
THC-0.8-7.0-2	4.5	3.0	2.1	7.0	300pcs
THC-0.8-7.5-2	4.5	3.0	2.1	7.5	300pcs
THC-0.8-8.0-2	4.5	3.0	2.1	8.0	300pcs
THC-0.8-0.5-2.6	5.0	3.6	2.7	0.5	450pcs
THC-0.8-1.0-2.6	5.0	3.6	2.7	1.0	450pcs
THC-0.8-1.5-2.6	5.0	3.6	2.7	1.5	300pcs
THC-0.8-2.0-2.6	5.0	3.6	2.7	2.0	300pcs
THC-0.8-2.5-2.6	5.0	3.6	2.7	2.5	250pcs
THC-0.8-3.0-2.6	5.0	3.6	2.7	3.0	250pcs
THC-0.8-3.5-2.6	5.0	3.6	2.7	3.5	200pcs
THC-0.8-4.0-2.6	5.0	3.6	2.7	4.0	200pcs
THC-0.8-4.5-2.6	5.0	3.6	2.7	4.5	400pcs
THC-0.8-5.0-2.6	5.0	3.6	2.7	5.0	400pcs
THC-0.8-5.5-2.6	5.0	3.6	2.7	5.5	350pcs
THC-0.8-6.0-2.6	5.0	3.6	2.7	6.0	350pcs
THC-0.8-6.5-2.6	5.0	3.6	2.7	6.5	300pcs
THC-0.8-7.0-2.6	5.0	3.6	2.7	7.0	300pcs
THC-0.8-7.5-2.6	5.0	3.6	2.7	7.5	300pcs
THC-0.8-8.0-2.6	5.0	3.6	2.7	8.0	300pcs
THC-0.8-8.5-2.6	5.0	3.6	2.7	8.5	250pcs
THC-0.8-9.0-2.6	5.0	3.6	2.7	9.0	250pcs
THC-0.8-9.5-2.6	5.0	3.6	2.7	9.5	250pcs
THC-0.8-10-2.6	5.0	3.6	2.7	10	250pcs
THC-0.8-0.5-3	5.5	4.0	3.1	0.5	450pcs
THC-0.8-1.0-3	5.5	4.0	3.1	1.0	450pcs
THC-0.8-1.5-3	5.5	4.0	3.1	1.5	300pcs
THC-0.8-2.0-3	5.5	4.0	3.1	2.0	300pcs
THC-0.8-2.5-3	5.5	4.0	3.1	2.5	250pcs
THC-0.8-3.0-3	5.5	4.0	3.1	3.0	250pcs
THC-0.8-3.5-3	5.5	4.0	3.1	3.5	200pcs
THC-0.8-4.0-3	5.5	4.0	3.1	4.0	200pcs
THC-0.8-4.5-3	5.5	4.0	3.1	4.5	400pcs
THC-0.8-5.0-3	5.5	4.0	3.1	5.0	400pcs
THC-0.8-5.5-3	5.5	4.0	3.1	5.5	350pcs
THC-0.8-6.0-3	5.5	4.0	3.1	6.0	350pcs
THC-0.8-6.5-3	5.5	4.0	3.1	6.5	300pcs
THC-0.8-7.0-3	5.5	4.0	3.1	7.0	300pcs
THC-0.8-7.5-3	5.5	4.0	3.1	7.5	300pcs
THC-0.8-8.0-3	5.5	4.0	3.1	8.0	300pcs
THC-0.8-8.5-3	5.5	4.0	3.1	8.5	250pcs
THC-0.8-9.0-3	5.5	4.0	3.1	9.0	250pcs
THC-0.8-9.5-3	5.5	4.0	3.1	9.5	250pcs
THC-0.8-10-3	5.5	4.0	3.1	10	250pcs

Part number	A	B	C	H	Number of taps included in the reel
THC-0.8-0.5-4	7.0	5.5	4.5	0.5	450pcs
THC-0.8-1.0-4	7.0	5.5	4.5	1.0	450pcs
THC-0.8-1.5-4	7.0	5.5	4.5	1.5	350pcs
THC-0.8-2.0-4	7.0	5.5	4.5	2.0	350pcs
THC-0.8-2.5-4	7.0	5.5	4.5	2.5	250pcs
THC-0.8-3.0-4	7.0	5.5	4.5	3.0	250pcs
THC-0.8-3.5-4	7.0	5.5	4.5	3.5	200pcs
THC-0.8-4.0-4	7.0	5.5	4.5	4.0	200pcs
THC-0.8-4.5-4	7.0	5.5	4.5	4.5	450pcs
THC-0.8-5.0-4	7.0	5.5	4.5	5.0	450pcs
THC-0.8-5.5-4	7.0	5.5	4.5	5.5	300pcs
THC-0.8-6.0-4	7.0	5.5	4.5	6.0	300pcs
THC-0.8-6.5-4	7.0	5.5	4.5	6.5	250pcs
THC-0.8-7.0-4	7.0	5.5	4.5	7.0	250pcs
THC-0.8-7.5-4	7.0	5.5	4.5	7.5	200pcs
THC-0.8-8.0-4	7.0	5.5	4.5	8.0	200pcs
THC-0.8-8.5-4	7.0	5.5	4.5	8.5	200pcs
THC-0.8-9.0-4	7.0	5.5	4.5	9.0	200pcs
THC-0.8-9.5-4	7.0	5.5	4.5	9.5	200pcs
THC-0.8-10-4	7.0	5.5	4.5	10	200pcs

### Dimension

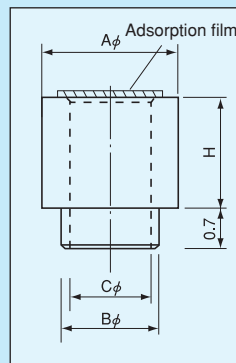

### Example of usage

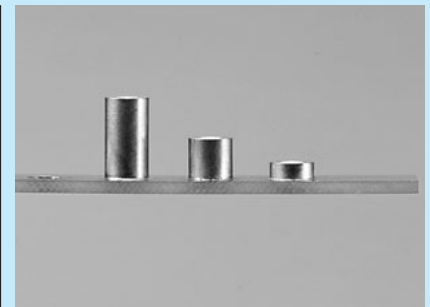

### Condition of fitting to the PC board

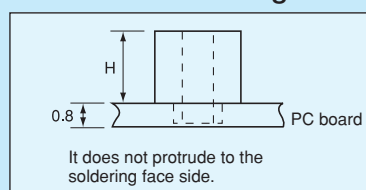

THC-0.8-□-□-B

Please specify-B.

- 100pcs/pack
- Adsorption films are not put on the bulk products.

# Through hole tap [THC-0.8 series] specification

## Recommended fitting land

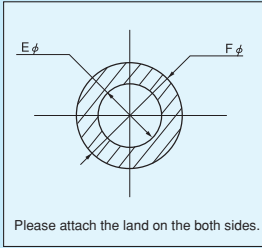

## Recommended metal mask

(Recommended metal mask thickness: 150 μ to 200 μ)

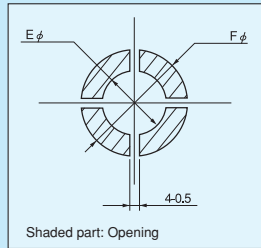

Part number	$\phi E$	$\phi F$
THC-0.8-□-2	3.2	5.5
THC-0.8-□-2.6	3.8	6.0
THC-0.8-□-3	4.2	6.5
THC-0.8-□-4	5.7	8.0

## Dimension of the reel

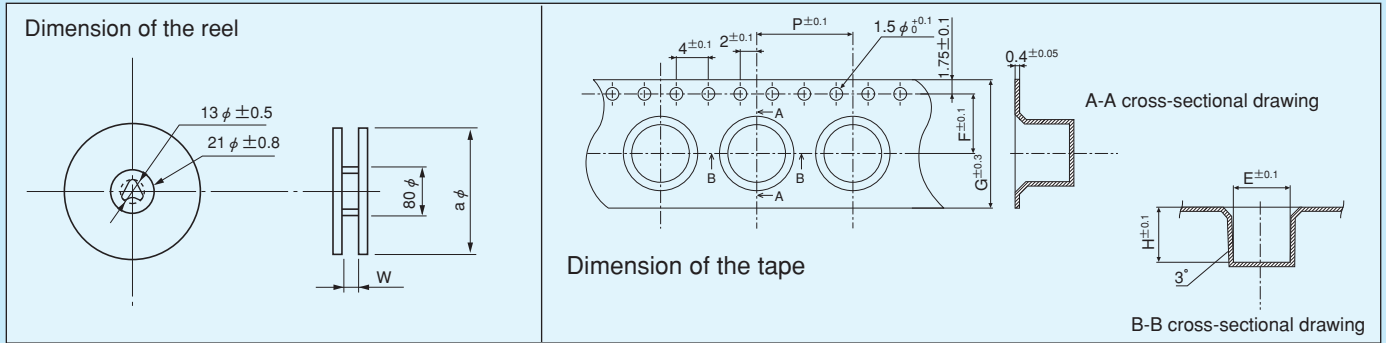

## Table of dimensions

Part number	Reel		Tape				
	a(φ)	W	E	F	G	H	P
THC-0.8-0.5-2	178	17.5	4.8	7.5	16	2.2	12
THC-0.8-1.0-2	178	17.5	4.8	7.5	16	2.2	12
THC-0.8-1.5-2	178	17.5	4.8	7.5	16	2.8	12
THC-0.8-2.0-2	178	17.5	4.8	7.5	16	2.8	12
THC-0.8-2.5-2	178	17.5	4.8	7.5	16	3.8	12
THC-0.8-3.0-2	178	17.5	4.8	7.5	16	3.8	12
THC-0.8-3.5-2	178	17.5	4.8	7.5	16	4.8	12
THC-0.8-4.0-2	178	17.5	4.8	7.5	16	4.8	12
THC-0.8-4.5-2	254	17.5	4.8	7.5	16	5.8	12
THC-0.8-5.0-2	254	17.5	4.8	7.5	16	5.8	12
THC-0.8-5.5-2	254	17.5	4.8	7.5	16	6.8	12
THC-0.8-6.0-2	254	17.5	4.8	7.5	16	6.8	12
THC-0.8-6.5-2	254	17.5	4.8	7.5	16	7.8	12
THC-0.8-7.0-2	254	17.5	4.8	7.5	16	7.8	12
THC-0.8-7.5-2	254	17.5	4.8	7.5	16	8.8	12
THC-0.8-8.0-2	254	17.5	4.8	7.5	16	8.8	12
THC-0.8-0.5-2.6	178	17.5	5.3	7.5	16	2.2	12
THC-0.8-1.0-2.6	178	17.5	5.3	7.5	16	2.2	12
THC-0.8-1.5-2.6	178	17.5	5.3	7.5	16	2.8	12
THC-0.8-2.0-2.6	178	17.5	5.3	7.5	16	2.8	12
THC-0.8-2.5-2.6	178	17.5	5.3	7.5	16	3.8	12
THC-0.8-3.0-2.6	178	17.5	5.3	7.5	16	3.8	12
THC-0.8-3.5-2.6	178	17.5	5.3	7.5	16	4.8	12
THC-0.8-4.0-2.6	178	17.5	5.3	7.5	16	4.8	12
THC-0.8-4.5-2.6	254	17.5	5.3	7.5	16	5.8	12
THC-0.8-5.0-2.6	254	17.5	5.3	7.5	16	5.8	12
THC-0.8-5.5-2.6	254	17.5	5.3	7.5	16	6.8	12
THC-0.8-6.0-2.6	254	17.5	5.3	7.5	16	6.8	12
THC-0.8-6.5-2.6	254	17.5	5.3	7.5	16	7.8	12
THC-0.8-7.0-2.6	254	17.5	5.3	7.5	16	7.8	12
THC-0.8-7.5-2.6	254	17.5	5.3	7.5	16	8.8	12
THC-0.8-8.0-2.6	254	17.5	5.3	7.5	16	8.8	12
THC-0.8-8.5-2.6	254	17.5	5.3	7.5	16	9.8	12
THC-0.8-9.0-2.6	254	17.5	5.3	7.5	16	9.8	12
THC-0.8-9.5-2.6	254	17.5	5.3	7.5	16	10.8	12
THC-0.8-10-2.6	254	17.5	5.3	7.5	16	10.8	12
THC-0.8-0.5-3	178	17.5	5.8	7.5	16	2.2	12
THC-0.8-1.0-3	178	17.5	5.8	7.5	16	2.2	12

Part number	Reel		Tape				
	a(φ)	W	E	F	G	H	P
THC-0.8-1.5-3	178	17.5	5.8	7.5	16	2.8	12
THC-0.8-2.0-3	178	17.5	5.8	7.5	16	2.8	12
THC-0.8-2.5-3	178	17.5	5.8	7.5	16	3.8	12
THC-0.8-3.0-3	178	17.5	5.8	7.5	16	3.8	12
THC-0.8-3.5-3	178	17.5	5.8	7.5	16	4.8	12
THC-0.8-4.0-3	178	17.5	5.8	7.5	16	4.8	12
THC-0.8-4.5-3	254	17.5	5.8	7.5	16	5.8	12
THC-0.8-5.0-3	254	17.5	5.8	7.5	16	5.8	12
THC-0.8-5.5-3	254	17.5	5.8	7.5	16	6.8	12
THC-0.8-6.0-3	254	17.5	5.8	7.5	16	6.8	12
THC-0.8-6.5-3	254	17.5	5.8	7.5	16	7.8	12
THC-0.8-7.0-3	254	17.5	5.8	7.5	16	7.8	12
THC-0.8-7.5-3	254	17.5	5.8	7.5	16	8.8	12
THC-0.8-8.0-3	254	17.5	5.8	7.5	16	8.8	12
THC-0.8-8.5-3	254	17.5	5.8	7.5	16	9.8	12
THC-0.8-9.0-3	254	17.5	5.8	7.5	16	9.8	12
THC-0.8-9.5-3	254	17.5	5.8	7.5	16	10.8	12
THC-0.8-10-3	254	17.5	5.8	7.5	16	10.8	12
THC-0.8-0.5-4	178	17.5	7.3	7.5	16	2.0	12
THC-0.8-1.0-4	178	17.5	7.3	7.5	16	2.0	12
THC-0.8-1.5-4	178	17.5	7.3	7.5	16	3.0	12
THC-0.8-2.0-4	178	17.5	7.3	7.5	16	3.0	12
THC-0.8-2.5-4	178	17.5	7.3	7.5	16	4.0	12
THC-0.8-3.0-4	178	17.5	7.3	7.5	16	4.0	12
THC-0.8-3.5-4	178	17.5	7.3	7.5	16	5.0	12
THC-0.8-4.0-4	178	17.5	7.3	7.5	16	5.0	12
THC-0.8-4.5-4	254	17.5	7.3	7.5	16	6.0	12
THC-0.8-5.0-4	254	17.5	7.3	7.5	16	6.0	12
THC-0.8-5.5-4	254	25.5	7.3	11.5	24	7.0	16
THC-0.8-6.0-4	254	25.5	7.3	11.5	24	7.0	16
THC-0.8-6.5-4	254	25.5	7.3	11.5	24	8.0	16
THC-0.8-7.0-4	254	25.5	7.3	11.5	24	8.0	16
THC-0.8-7.5-4	254	25.5	7.3	11.5	24	9.0	16
THC-0.8-8.0-4	254	25.5	7.3	11.5	24	9.0	16
THC-0.8-8.5-4	254	25.5	7.3	11.5	24	10	16
THC-0.8-9.0-4	254	25.5	7.3	11.5	24	10	16
THC-0.8-9.5-4	254	25.5	7.3	11.5	24	11	16
THC-0.8-10-4	254	25.5	7.3	11.5	24	11	16

For surface mounting