

Hybrid connection terminal for surface mounting [HZR series] (10pcs/pack)

- By inserting the upper part of this terminal in a through hole and soldering it, a hybrid IC for surface mounting, etc. can be easily made.
- Material
Pin part: Phosphor bronze
Resin part: PCT black (UL94V-0)
- Finish G:Gold plating over nickel base
S: Tin plating over nickel base
- Rated current: 2A
- Insulation resistance: 500MΩ or over
- Withstand voltage: HZR-1:700V AC, DC per minute
HZR-3:1000V AC, DC per minute
- Printed board fitting hole diameter: ϕ 0.7

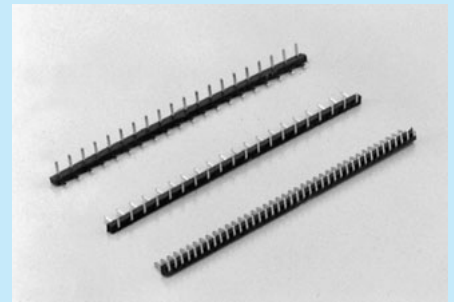

Example of usage

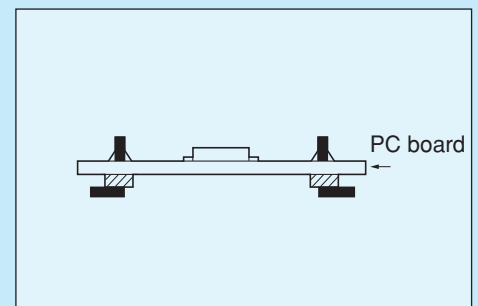

Part number

Part number	P	Maximum number of pins connected	Plating
HZR-1-G	1.27	40P	Gold
HZR-1-S	1.27	40P	Tin
HZR-3-G	2.54	20P	Gold
HZR-3-S	2.54	20P	Tin

How to order

HZR-1-G-10P

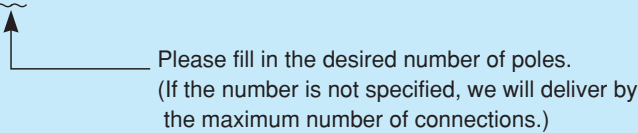

Recommended land diameter (TH side)

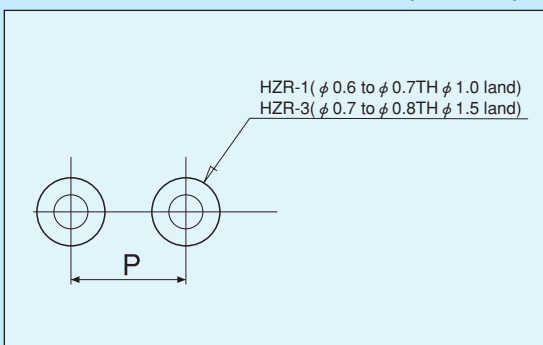

Recommended land diameter (SMT side)

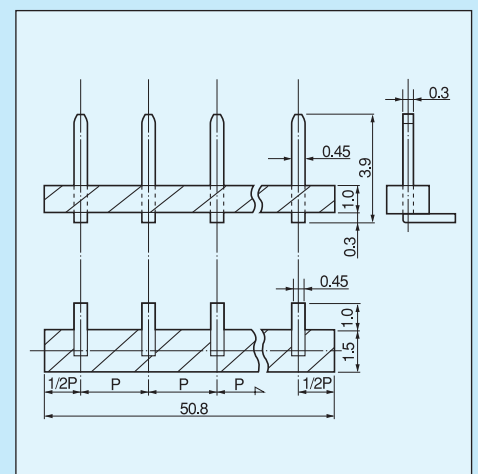
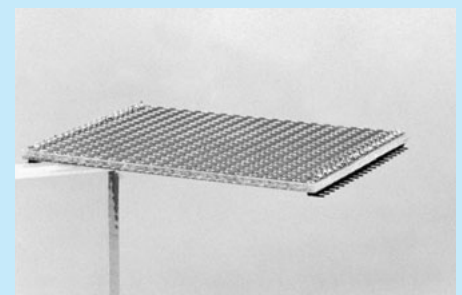
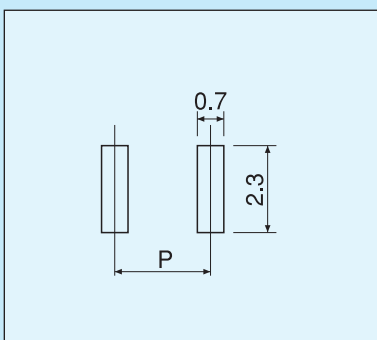

For surface mounting