

**Conduction pin (angle free) for surface mounting [FAL-0.6]**

- Male pin to conduct PC board angle freely.
- Adaptive socket is FAC-0.6.
- Material : Copper Alloy
- Finish : Gold plating over nickel base

**■ Specification (In case of connect with FAC-0.6)**

Rated current : 10A  
 Contact resistance : 20mΩ or less  
 Insertion / removal frequency : 100 times or less  
 Operating temperature range : -40 to +125°C

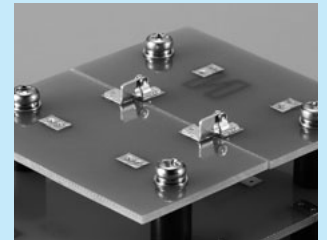
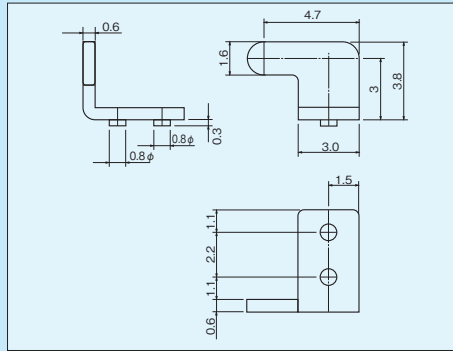

**■ Part number**

Part number	Package
FAL-0.6	Bulk(100pcs/pack)
FAL-0.6-T	Reel(250pcs/reel)

**■ Recommended land diameter**

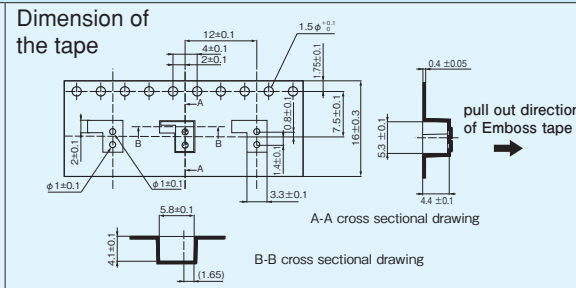
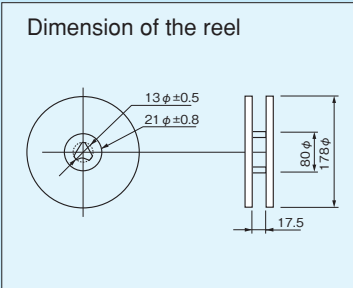
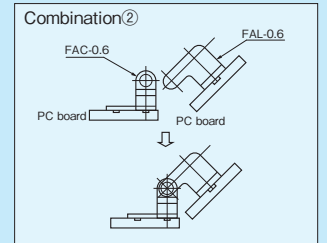
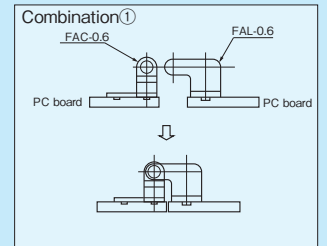
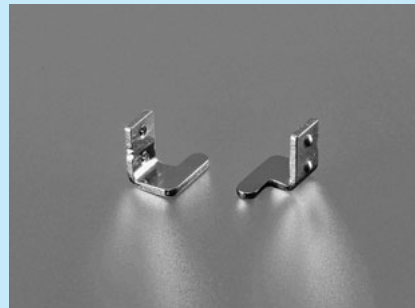
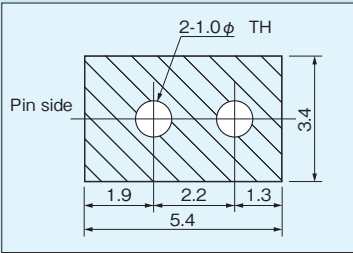

**Conduction socket (angle free) for surface mounting [FAC-0.6]**

- Can conduct PC board angle freely by combining with FAL-0.6.
- Material : Copper Alloy
- Finish : Gold plating over nickel base

**■ Recommended land diameter**

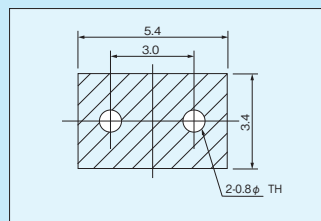

**■ Part number**

Part number	Package
FAC-0.6	Bulk(100pcs/pack)
FAC-0.6-T	Reel(250pcs/reel)

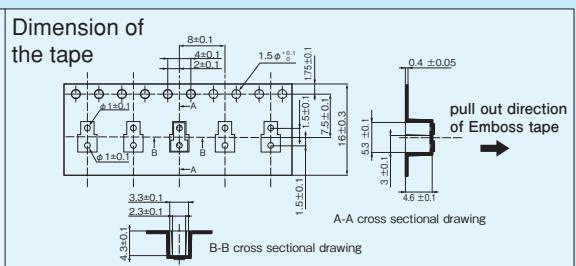
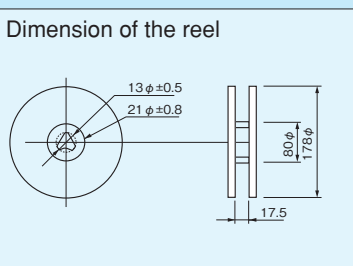
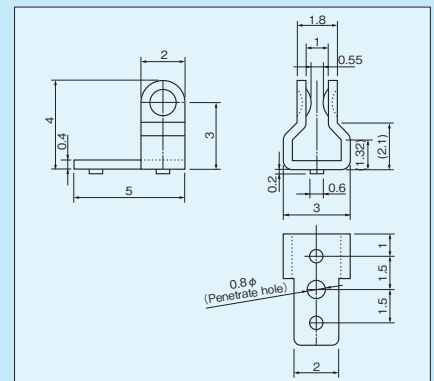

※ The main purpose is to conduct the product, not to fix 2 PC boards.